

Martin® SQC2S™ Cleaner

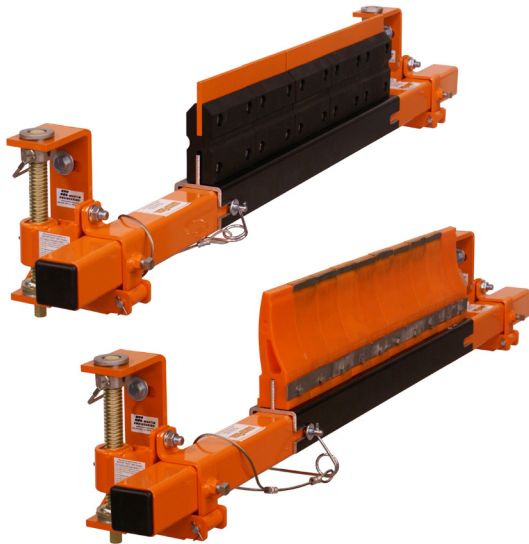

The [Martin® SQC2S™ Cleaner](#) incorporates individually-cushioned tungsten carbide blades for effective cleaning without risk to belt, splice, or blade. Installed in the secondary cleaner position, the Martin® SQC2S™ Cleaner's blade buffers cushion impact and maintains cleaning pressure.

BENEFITS

- Cushioned Blades Maintain Efficiency**
 Patented rubber buffers maintain cleaning pressure while deflecting to allow splices to pass.
- Built for Tough Conditions**
 Rugged construction withstands punishing applications, like high-speed belts and high-tonnage loads.
- Easy Cartridge Removal**
 The procedure is simple: remove pin, slide out cartridge, service, and return.
- Easy Adjustment of Cleaning Pressure**
 Martin® SQC2S™ Tensioners allows simple alteration of blade-to-belt pressure to maintain cleaning efficiency regardless of blade wear. Lock pin keeps tensioner in place to maintain constant tension.
- Fits in Tight Spaces**
 Compact design allows installation in close quarters; narrow profile resists material buildup.
- Blades to Match Application**
 Specify tungsten carbide tips for normal, acidic, or high-impact conditions. Blades conform to belt profile by adjusting individually to provide continuous contact across the belt.
- Handles Reversing Belts and Belt Rollback**
 Rubber buffers allow for reversal of belt direction without damage to belt.

ACCESSORIES

PART	P/N
Martin® SQC2™ Split-Cover Door	38014-SQCS
Martin® Hanger Mount Heavy-Duty Assembly	34233-HD
Martin® SQC2S™ Square Mainframe Tensioner	38664
Martin® SQC2S™ Square Mainframe Tensioner HD	38664-HD

TECHNICAL DATA SHEET

NOMENCLATURE

XXXXX-XX X XX XX X X X

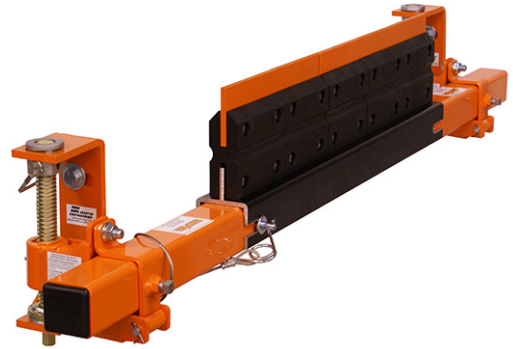
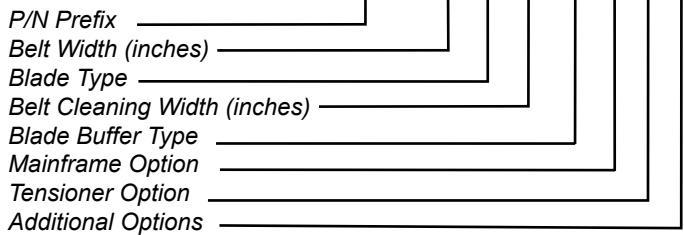

P/N PREFIX

SQC2S: Standard Assembly
SQC2MS: Mini SQC2S™ Blades on Standard Assembly

BLADE TYPE

C: Corrosion Resistant with Tungsten Carbide Tips
G: Acid-Resistant for belts with clips
H: Acid-Resistant
R: General Applications and Reversing Belts—Tungsten Carbide
S: Corrosion Resistant
Ø: No Blades

BLADE CLEANING WIDTH

Full belt width or Approx. 6 inches less belt width.

BLADE BUFFER TYPE

MR: Molded Rubber
FR: Flame-Retardant Rubber
ØØ: No Buffers

MAINFRAME OPTIONS

P: Painted
S: Stainless

TENSIONER OPTIONS

T: Tensioner
S: 316 SS Tensioner
H: HD Tensioner
A: 316 SS HD Tensioner
Ø: No Tensioner

ADDITIONAL OPTIONS

Ø: None
D: Dust-Tight Steel Cover Door

MARTIN® SQC2S™ BLADES*

COLOR	GENERAL APPLICATION	Replacement Blade P/N
—	Corrosion Resistant Stainless Steel with TC Tips	SC-10002-C
Orange	Acid-Resistant: TC Blade for mechanical splices	SC-10002-G
Orange	Acid-Resistant: TC Blade	SC-10002-H
Orange	General Applications and Reversing Belts: TC Blade	SC-10002-R
—	Corrosion Resistant Stainless Steel	SC-10002-S

* Maximum belt speed for Martin® SQC2S™ blades is 1000 FPM.
 For other applications, please contact your Martin Engineering representative.
 TC = Tungsten

TECHNICAL DATA SHEET

NOMENCLATURE

SQC2S-XX X XX XX X X X

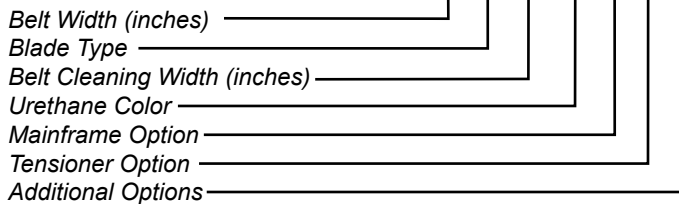

BLADE TYPE

C: Tungsten Carbide with Stainless Insert
R: Reversing Belts–Urethane
S: Stainless Insert
T: Tungsten Carbide
U: Urethane
Ø: No Blades

BLADE CLEANING WIDTH

Full belt width or Approx.
 6 inches less belt width.

URETHANE COLOR

O3: Orange Urethane
B3: Brown Urethane
G3: Green Urethane
N3: Navy Blue Urethane

MAINFRAME OPTIONS

P: Painted
S: Stainless

TENSIONER OPTIONS

T: Tensioner
S: 316 SS Tensioner
H: HD Tensioner
A: 316 SS HD Tensioner
Ø: No Tensioner

ADDITIONAL OPTIONS

Ø: None
D: Dust-Tight Steel Cover Door

MARTIN® SAF2™ STYLE 3-INCH WIDE BLADES*

COLOR	GENERAL APPLICATION	Replacement Blade P/N
Orange	General Applications: TC Blade with Stainless Insert	38718-C
Orange	General Applications: Stainless Insert	38718-S
Orange	General Applications: TC Blade	38718-T
Orange	General Applications: Urethane Blade	38718-U
Orange	General Applications: Reversing Urethane Blade	38718-UR
Brown	Acid-Resistant: TC Blade with Stainless Insert	38718-CBR
Brown	Acid-Resistant: Stainless Insert	38718-SBR
Brown	Acid-Resistant: TC Blade	38718-TBR
Brown	Acid-Resistant: Urethane Blade	38718-UBR
Brown	Acid-Resistant: Reversing Urethane Blade	38718-URBR
Green	Hi Temperature: TC Blade with Stainless Insert 300°F continuous 350°F intermittent	38718-CGR
Green	Hi Temperature: Stainless Insert 300°F continuous 350°F intermittent	38718-SGR
Green	Hi Temperature: TC Blade 300°F continuous 350°F intermittent	38718-TGR
Green	Hi Temperature: Urethane Blade 300°F continuous 350°F intermittent	38718-UGR
Green	Hi Temperature: Reversing Urethane Blade 300°F continuous 350°F intermittent	38718-URGR
Navy Blue	TC Blade with Stainless Insert for use with sticky or tacky materials	38718-CNB
Navy Blue	TC Blade for use with sticky or tacky materials	38718-TNB
Navy Blue	Urethane Blade for use with sticky or tacky materials	38718-UNB
Navy Blue	Reversing Urethane Blade for use with sticky or tacky materials	38718-URNB

* Maximum belt speed for Martin® SAF2™ style 3-inch wide blades is 800 FPM.
 For other applications, please contact your Martin Engineering representative.
 TC = Tungsten

TECHNICAL DATA SHEET

DIMENSIONS

Belt Width		DIM "A" in. (mm)		# of Martin® SQC2S™ Blades (Belt Width minus 6")	# of Martin® SQC2S™ Blades (Full Belt Width)	# of Martin® SAF2™ Blades* (Belt Width minus 6")	# of Martin® SAF2™ Blades* (Full Belt Width)
18	(450)	48.00	(1219)	2	3	4	6
24	(600)	54.00	(1372)	3	4	6	8
30	(750)	60.00	(1524)	4	5	8	10
36	(900)	66.00	(1676)	5	6	10	12
42	(1050)	72.00	(1829)	6	7	12	14
48	(1200)	78.00	(1981)	7	8	14	16
54	(1350)	84.00	(2134)	8	9	16	18
60	(1500)	90.00	(2286)	9	10	18	20
66	(1650)	96.00	(2438)	10	11	20	22
72	(1800)	102.00	(2591)	11	12	22	24
78	(1950)	108.00	(2743)	12	13	24	26
84	(2100)	114.00	(2896)	13	14	26	28
90	(2250)	120.00	(3048)	14	15	28	30
96	(2400)	126.00	(3200)	15	—	30	32

*Quantity represents total blades on the cartridge. Each cartridge has a minimum of two urethane blades, one on each end of the cartridge. The blades in between are available in either urethane or tungsten carbide.

SQC2MS-XXXXXXXXXX

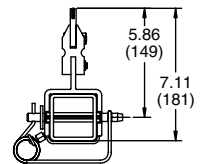
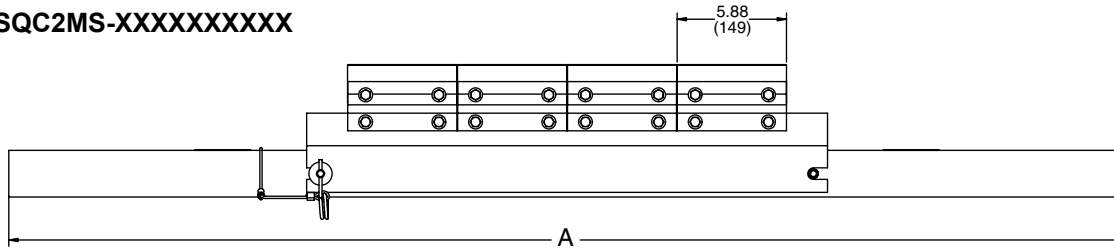

SQC2S-XXXXXXXXXX

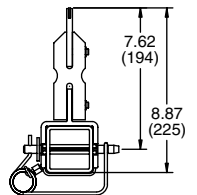
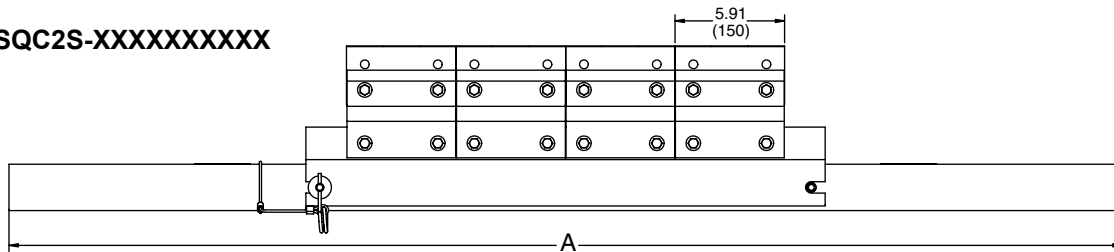

SQC2S-XXXXXX3XXX

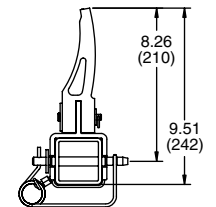
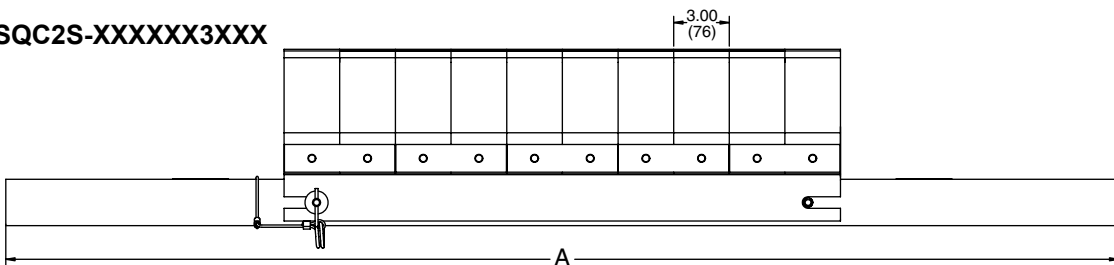

SQC2S-XXRXXX3XXX

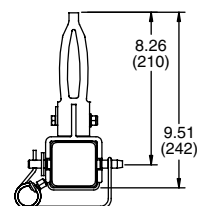
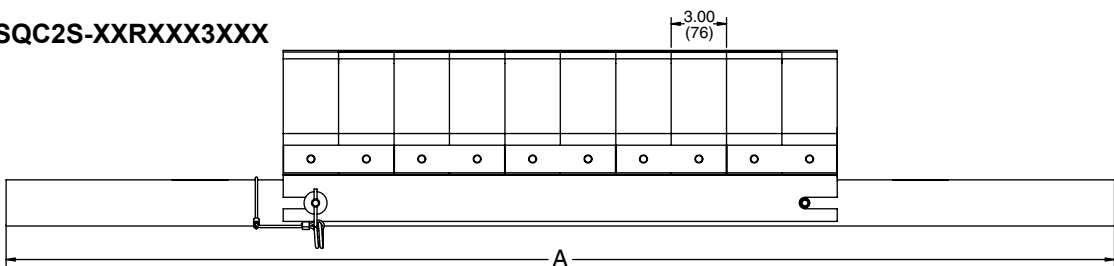

TECHNICAL DATA SHEET

APPLICATION NOTES

Martin Engineering recommends that the Martin® SQC2S™ Cleaner be installed so the cleaning blade contacts the belt at a point 2 to 4 in. (51 to 102 mm) after the point where the belt leaves the head (discharge) pulley. If obstructions prevent installation at this point, or if additional cleaners are desired, the cleaner should be installed 2 to 4 in. (51 to 102 mm) past the point where the belt leaves the support idler.

See your Martin Engineering representative for more information, or visit www.martin-eng.com.

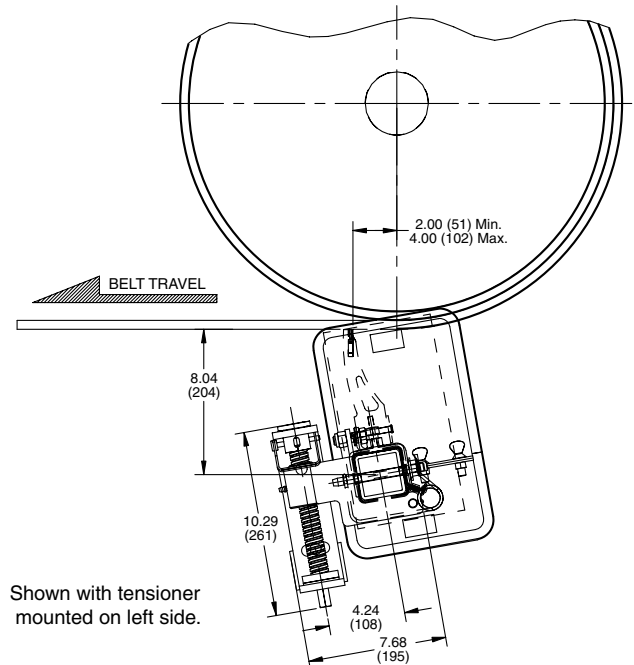
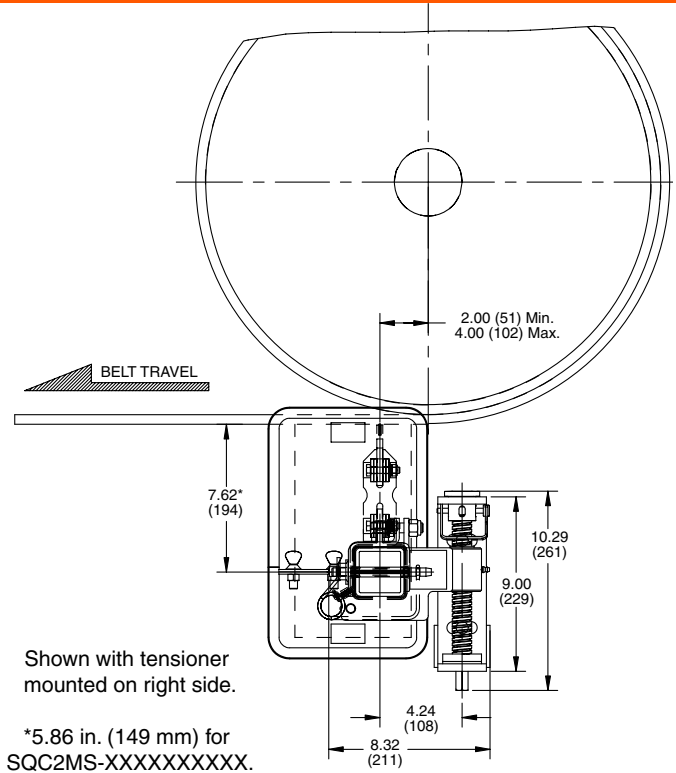
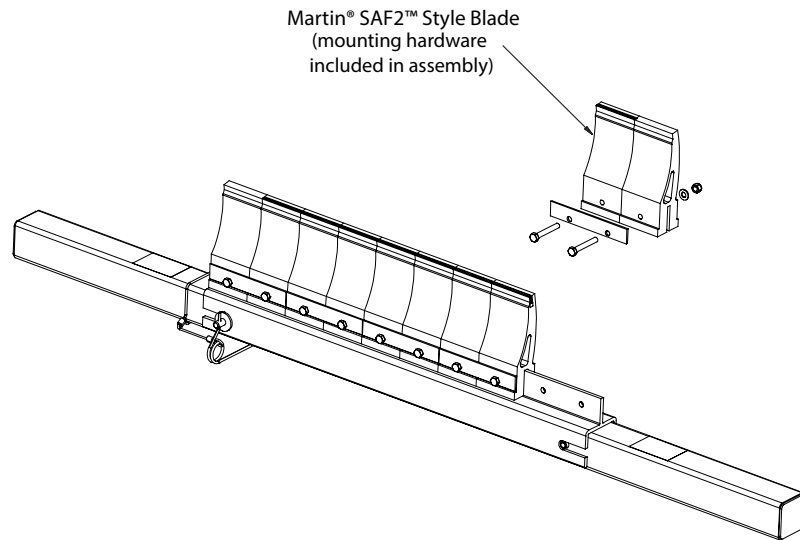
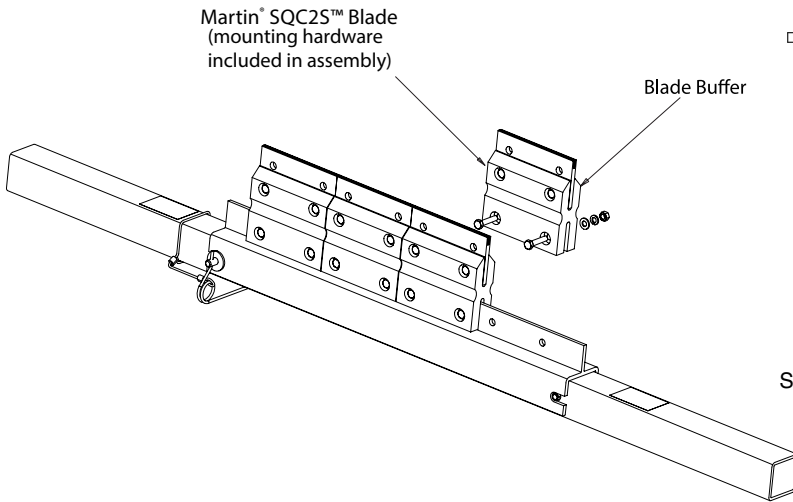

Martin Engineering USA
 One Martin Place
 Neponset, IL 61345-9766 USA
 800 544 2947 or 309 852 2384
 Fax 800 814 1553
www.martin-eng.com

**COMPANY WITH
 QUALITY SYSTEM
 CERTIFIED BY DNV
 = ISO 9001:2008 =**

Problem Solved™ GUARANTEED!

Form No. L3828-06/14
 © Martin Engineering Company 2011, 2014